

Rea

ŁAZIENKA Z WYOBRAŻNIĄ

Instructions de montaj

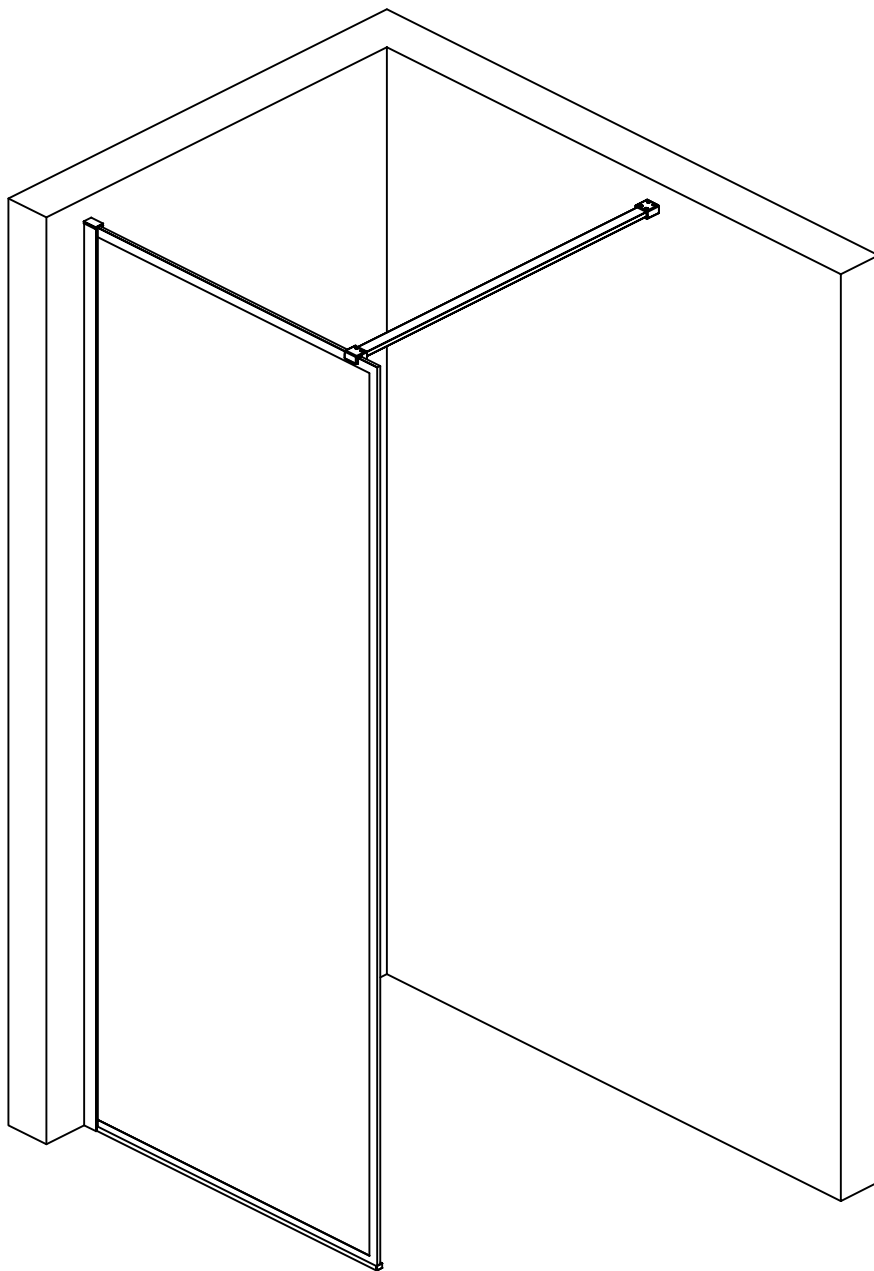

BLER

1. Note de instalare

Înainte de a începe montajul, vă rugăm să verificați dacă toate elementele conținute în manual sunt incluse în pachet și dacă nu sunt deteriorate. În caz de deteriorare sau lipsă de articole, vă rugăm să contactați imediat vânzătorul.

NOTĂ: NU INSTALATI ELEMENTE DETERMINATE

- a) Înainte de a începe montajul: vă rugăm să citiți manualul, să verificați dacă aveți instrumentele și componentele necesare ale cabinei. Procedați conform instrucțiunilor.
- b) Va rugăm să nu utilizați unelte ascuțite sau dure în timpul instalării pentru a evita deteriorarea sticlei. Folosiți un ciocan de cauciuc dacă este necesar.

2. Instrumente necesare (nu sunt incluse):

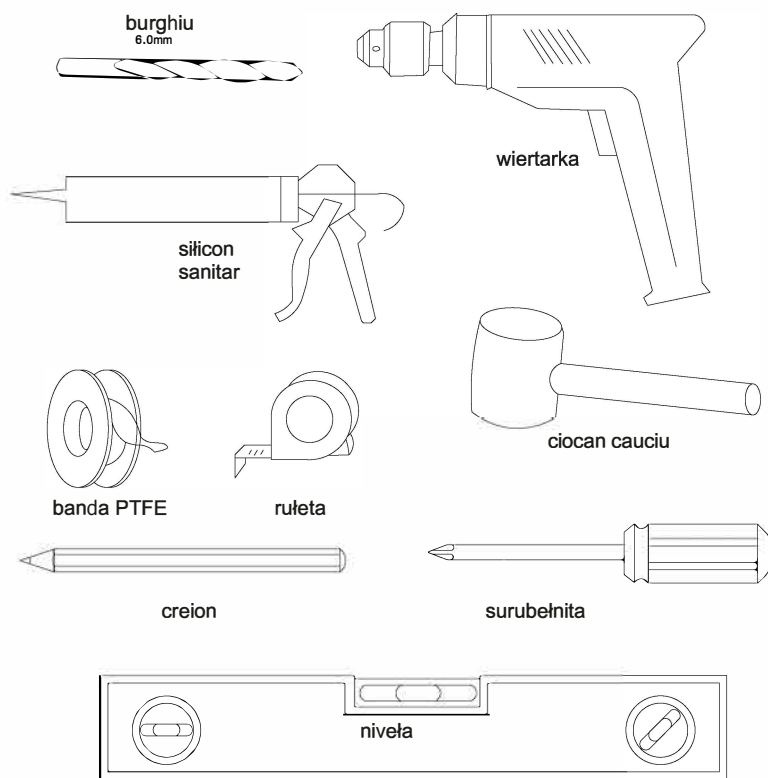









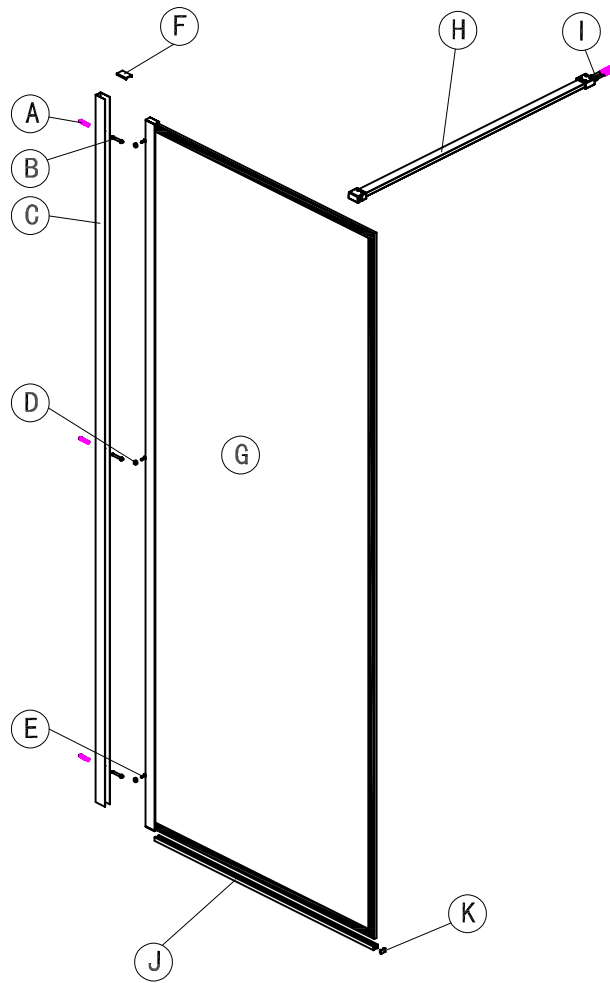





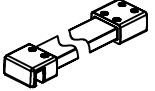

3. ATENTIE!

1. Persoanele care se simt slăbite sau sunt după ce au băut alcool nu ar trebui să folosească cabina.
2. Persoanele care suferă de boli de inimă și hipertensiune arterială ar trebui să fie deosebit de atenți când folosesc cabina.
3. Copiii și persoanele în vârstă ar trebui să folosească cabina sub supravegherea adulților.
4. Vă rugăm să aveți grijă deosebită când intrați și ieșiți din cabină. Pentru a evita deteriorarea cabinei și pierderea echilibrului, vă rugăm să nu vă sprijiniți de perete.
5. Vă rugăm să ajustați timpul de încălzire în funcție de starea dumneavoastră de bine.
6. Este interzisă pornirea apei calde numai la reglarea temperaturii apei.
7. Este interzis fumatul în cabină.

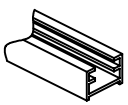
4. Curățare și întreținere

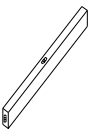
1. Curățarea zilnică se poate face cu produse de curățare obișnuite și o cârpă moale. Nu este recomandabil să folosiți agenți pe bază de acetonă și amoniac.
2. Petele pot fi îndepărtate cu oțet.
3. După curățare, vă rugăm să lăsați ușa deschisă să se usuce mai repede.

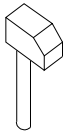
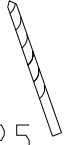

<p>A</p>  <p>X5</p>	<p>B</p>  <p>ST4. 2x32 X3</p>	<p>C</p>  <p>X1</p>	<p>D</p>  <p>X3</p>	<p>E</p>  <p>ST3. 5x9. 5 X3</p>	<p>F</p>  <p>X1</p>	<p>G</p>  <p>X1</p>	<p>H</p>  <p>X1</p>
<p>I</p>  <p>ST4. 2x32 X2</p>	<p>J</p>  <p>X1</p>	<p>K</p>  <p>X1</p>					
				 <p>∅6</p>		 <p>∅2.5</p>	